



U-TUBE FIXED & REMOVEABLE BUNDLE

HEAT EXCHANGERS

For severe temperature differences between entering hot fluid and cold fluid to minimize thermal shock

- Removable tube bundle.
- Operating pressure for tubes 150 PSI.
- Operating pressure for shell 250 PSI.
- Operating temperature 400 °F.
- Computer generated data sheet available for any application
- Can be customized to fit any applications.
- Option up to 600 °F

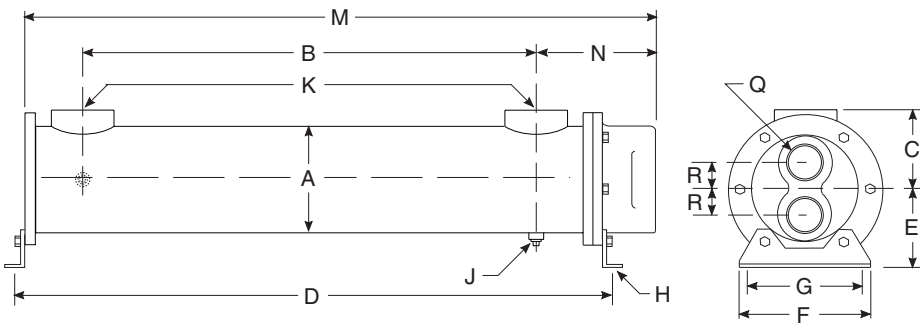

TWO PASS (TP)

Model	M	N	Q NPT	R
UCS-614	17.79			
UCS-624	27.79	3.70	1.00	1.00
UCS-630	33.79			
UCS-636	39.79			
UCS-712	16.56			
UCS-718	22.56	4.85	1.00	.88
UCS-724	28.56			
UCS-730	34.56			
UCS-736	40.56			
UCS-814	18.44			
UCS-824	28.44	4.82	1.25	1.06
UCS-830	34.44			
UCS-836	40.44			

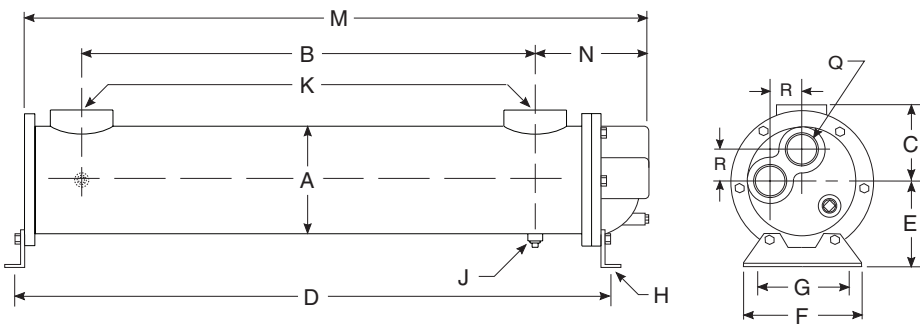

FOUR PASS (FP)

Model	M	N	Q NPT	R
UCS-614	17.78			
UCS-624	27.78	3.68	.75	1.00
UCS-630	33.78			
UCS-636	39.78			
UCS-712	16.53			
UCS-718	22.53	4.82	.75	
UCS-724	28.53			
UCS-730	34.53			
UCS-736	40.53			
UCS-814	18.44			
UCS-824	28.44	4.81	.75	1.25
UCS-830	34.44			
UCS-836	40.44			

COMMON DIMENSIONS

Model	A	B	C	D	E	F	G	H	J NPT	K NPT	Weight	Model
UCS-614		10.0		18.38							17	UCS-614
UCS-624	3.25	20.0	2.63	28.38	2.75	4.18	1.62	.39 x 1.00 Thru Slot	.25 (2x)	1.00	24	UCS-624
UCS-630		26.0		34.38							30	UCS-630
UCS-636		32.0		40.38							36	UCS-636
UCS-712		7.0		16.75							18	UCS-712
UCS-718	3.75	13.0	2.88	22.75	3.62	5.25	1.50	.39 x 1.00 Thru Slot	.25 (2x)	1.50	20	UCS-718
UCS-724		19.0		28.75							22	UCS-724
UCS-730		25.0		34.75							24	UCS-730
UCS-736		31.0		40.75							26	UCS-736
UCS-814		9.0		19.09							32	UCS-814
UCS-824	4.25	19.0	3.12	29.09	3.50	4.25	1.75	.39 x 1.00 Thru Slot	.25 (2x)	1.50	41	UCS-824
UCS-830		25.0		35.09							47	UCS-830
UCS-836		31.0		41.09							53	UCS-836

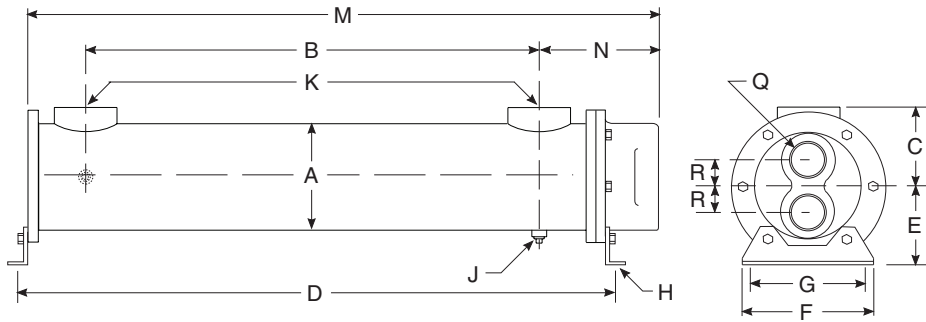

TWO PASS (TP)

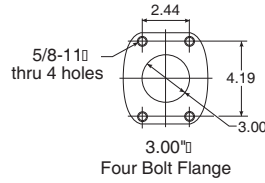
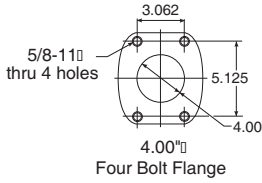

Model	M	N	Q NPT	R
UCS-1024	28.88			
UCS-1036	40.88	4.94	1.50	1.19
UCS-1048	52.88			
UCS-1224	29.17			
UCS-1236	41.17	5.35	2.00	1.44
UCS-1248	53.17			
UCS-1260	65.17			
UCS-1272	77.17			
UCS-1284	89.17			
UCS-1724	30.13			
UCS-1736	42.13	7.31	2.50	1.88
UCS-1748	54.13			
UCS-1760	66.13			
UCS-1772	78.13			
UCS-1784	90.13			
UCS-2036	43.91			
UCS-2048	55.91	9.57	3.00	2.50
UCS-2060	67.91			
UCS-2072	79.91			
UCS-2084	91.91			

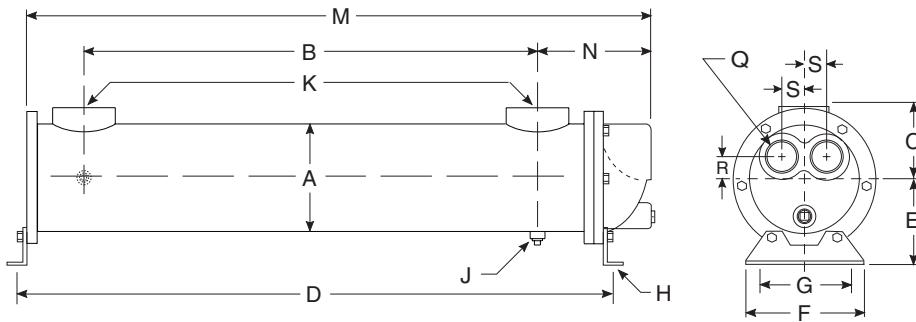

FOUR PASS (FP)

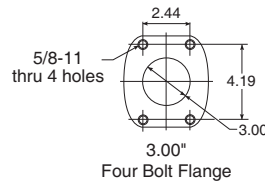
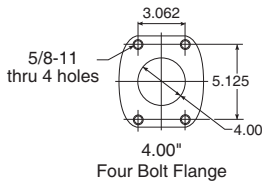

Model	M	N	Q NPT	R	S
UCS-1024	29.21				
UCS-1036	41.21	5.27	1.00	.75	1.19
UCS-1048	53.21				
UCS-1224	29.58				
UCS-1236	41.58	5.76	1.50	1.06	1.44
UCS-1248	53.58				
UCS-1260	65.58				
UCS-1272	77.58				
UCS-1284	89.58				
UCS-1724	29.78				
UCS-1736	41.78	6.96	2.00	1.38	1.88
UCS-1748	53.78				
UCS-1760	65.78				
UCS-1772	77.78				
UCS-1784	89.78				
UCS-2036	44.00				
UCS-2048	56.00	9.66	2.50	1.75	2.50
UCS-2060	68.00				
UCS-2072	80.00				
UCS-2084	92.00				

COMMON DIMENSIONS

Model	A	B	C	D	E	F	G	H	J NPT	K NPT	K SAE	Weight	Model
UCS-1024		19.00		29.13							#24	55.00	UCS-1024
UCS-1036	5.25	31.00	3.69	41.13	4.00	5.25	2.00	.44 x 1.00 thru slot	.375	1.50	1.875-12 SAE O-Ring	70.00	UCS-1036
UCS-1048		43.00		53.13								85.00	UCS-1048
UCS-1224		18.25		29.59							#32	83.00	UCS-1224
UCS-1236		30.25		41.59								108.00	UCS-1236
UCS-1248	6.25	42.25	4.19	53.59	4.50	6.25	2.50	.44 x 1.00 thru slot	.375	2.00	2.50-12 SAE O-Ring	132.00	UCS-1248
UCS-1260		54.25		65.59								158.00	UCS-1260
UCS-1272		66.25		77.59								182.00	UCS-1272
UCS-1284		78.25		89.59								206.00	UCS-1284
UCS-1724		17.00		29.50							3.0"	138.00	UCS-1724
UCS-1736		29.00		41.50								180.00	UCS-1736
UCS-1748	8.00	41.00	5.06	53.50	5.75	8.25	3.50	.44 x 1.00 thru slot	.375	3.00	Four Bolt Flange	219.00	UCS-1748
UCS-1760		53.00		65.50								258.00	UCS-1760
UCS-1772		65.00		77.50								300.00	UCS-1772
UCS-1784		77.00		89.50								342.00	UCS-1784
UCS-2036		28.50		42.63							4.0"	620.00	UCS-2036
UCS-2048	10.75	40.50	6.88	54.63	8.00	11.50	5.00	.781 x 1.25 thru slot	.50	4.00	Four Bolt Flange	670.00	UCS-2048
UCS-2060		52.50		66.63								730.00	UCS-2060
UCS-2072		64.50		78.63								820.00	UCS-2072
UCS-2084		76.50		90.63								870.00	UCS-2084